

Emulation and remote experimentation as support resources in a PBL approach for control systems

La emulación y la experimentación remota como recursos de apoyo en un enfoque de aprendizaje basado en proyectos para sistemas de control

Liliana Fernández-Samacá^{1,2}, José Miguel Ramírez Scarpetta¹, Martha Lucia Orozco-Gutiérrez¹*

¹Universidad del Valle, Escuela de Ingeniería Eléctrica y Electrónica, Grupo de Investigación en Control Industrial (GICI), Calle 13 N.º 100-00, Edificio 353, Ciudad Universitaria Meléndez, Cali, Valle, Colombia.

²Universidad Pedagógica y Tecnológica de Colombia, Escuela de Ingeniería Electrónica, Calle 4 sur N.º 15-134, Sogamoso, Boyacá, Colombia.

(Recibido el 9 de octubre de 2009. Aceptado el 7 de abril de 2010)

Abstract

This paper presents the use of a platform with emulation and remote experimentation tools to support a Project-Based Learning approach for courses of linear-control systems. Emulation and remote experimentation are incorporated as experimentation resources in the academic activities of the approach. The platform resources allow defining projects within new contexts and observing the dynamics of control complex problems from diverse nature. Moreover, emulation is used to experiment with non-available systems in the laboratory and observe the controller performance before implementation in real contexts. This work describes the learning approach, platform, and its different operation conditions. These conditions are shown through the emulation of a DC motor model with oscillating mode. Finally, this paper presents the results of a survey used to evaluate the platform, emphasizing on the assessment of the emulation tool as a learning resource.

----- *Keywords:* emulation, remote experimentation, control education, project-based learning

* Autor de correspondencia: teléfono: + 57 + 8 +772 35 56, fax: + 57 + 8 +771 16 93, correo electrónico: liliana.fernandez@uptc.edu.co. (L. Fernández)

Resumen

Este artículo presenta la utilización de una plataforma con herramientas de emulación y experimentación remota como recursos de apoyo en un enfoque de aprendizaje basado en proyectos para cursos de sistemas de control lineal. La emulación y la experimentación remota se incorporan como recursos de experimentación en las actividades académicas de este enfoque. Los recursos de la plataforma permiten la definición de proyectos en nuevos contextos y observar la dinámica de problemas complejos de control de diversa naturaleza. Adicionalmente, la emulación se utiliza para experimentar con sistemas no disponibles en el laboratorio y observar el desempeño de los controladores antes de su implementación en contextos reales. Este trabajo describe el enfoque de aprendizaje, la plataforma, y sus diferentes condiciones de operación. Estas condiciones se muestran a través de la emulación de un modelo de un motor DC con modo oscilante en la carga. Por último, este documento presenta los resultados de la encuesta utilizada para evaluar la plataforma, haciendo énfasis en la evaluación de la herramienta de emulación como recurso de aprendizaje.

---- *Palabras clave:* emulación, experimentación remota, educación en control, aprendizaje basado en proyectos

Introduction

Education in engineering requires new methodologies and learning resources to improve the professional performance of graduate engineers. Some educational approaches like Project-Based Learning (PBL) facilitate learning difficult subjects and allow developing transversal skills like: team work, communication abilities, leadership, time management, etc. PBL has been used with notable results in universities around the world, for example: Aalborg University in Denmark [1], the University of Louvain in Belgium [2], Sherbrooke University in Canada [3]. There are many experiences using PBL in technical subjects such as circuits analysis [4], digital signal processing [5], analog electronic circuits [6], etc. In Latin America, there are specific experiences in control systems at *Universidad de los Andes* [7] and at *Instituto Tecnológico de Estudios Superiores de Monterrey* in Mexico [8].

Communication and information technologies offer new possibilities for engineering education. The use of platforms for learning management and

platforms with specialized tools are more common in the teaching and learning of engineering. The combination of new learning approaches and technology generates new learning environments and learning resources. Nowadays, it is possible to find diverse technological resources for control learning. Some available web-based resources have simulation tools and user interfaces that use Java applets to define plant parameters, analyze control-system performance, and design control strategies in real plants. For example, [9, 10] present applications made by using Easy Java Simulations [11] — this tool facilitates the design of applets in Java that can be executed by means of any web browser—. Other resources combine software and hardware, and their access can be remote or local. These different options provide new experimentation environments for control systems that include simulation, emulation (real time simulation), remote experimentation, and prototype plants.

In reference [12], the authors classify experimentation environments according to resource nature and the access to resources. The

accessing criterion defines two ways: remote access and local access (depending if it does or does not require internet access). The nature criterion refers to whether the resource can be real or simulated. The current trend in the design of resources for control learning aims to develop real resources with remote access; most works present platforms and tools to drive real processes via internet (remote experimentation), for example, papers [13-15]. But, how can these resources be used in an educational approach like PBL? This work emphasizes on the use of emulation and remote experimentation in a PBL approach to increase experimentation resources for the teaching and learning of linear control systems in the Electronic Engineering Undergraduate Program at *Universidad del Valle*, Colombia. In this experience, the emulation and remote experimentation tools are available on a platform called PERI (*Plataforma de Experimentación Remota para Educación en Ingeniería – Remote Experimentation Platform for Engineering Education*) [16]. PERI allows remote operations of plants, simulation and analysis of systems, distributed simulation of tasks and distributed emulation of physical system models.

PERI has been incorporated as experimentation resource in the PBL approach designed for the control courses. The use of the platform allows defining projects within new contexts and observing the dynamics of control complex problems from diverse nature. The definition of context projects is important for a PBL approach; since learning is encouraged by carrying out projects that aim to solve real problems, recreating actual circumstances that motivate students to learn while they work at seeking solutions to the problem. Thus, students manage their own learning and learn topics when they need them. The use of the platform also lets students manage their experimentation time according to their learning process and to the development of the project. Moreover, the emulation of systems permits students to experiment with non-available systems in the laboratories and test controllers before implementation in a real context.

Project-based learning approach in linear control courses

The linear-control-system area in Electronics Engineering at *Universidad del Valle* has four courses on linear-control systems, two theoretical courses, and two lab courses. In the control courses, academic and evaluation activities are designed according to the PBL approach. Also, support resources for these activities are chosen according to this approach [17]. The defined approach has two important aspects: the problem and the project. The problem is defined by teacher staff from three factors: the context, variable, and objective control. The project is the ‘road’ to solve the problem. Each project is executed through four stages and each stage is developed by a student team. The team is advised by teachers and an expert on specific topics of the problem. The distribution of stages for the first level (one theory course and one lab course) is shown in figure 1. This course corresponds to Fundamentals of Linear-Control Systems. To design the problem, the context is chosen according to kinds of industries within the University’s location. This confronts students to common problems of professional work and allows that the industries become support resources for the learning. The context is a reference to solve the problem, but students do not solve the problem in the industry.

In short, the definition of the problems establishes two different experimentation resources according to the context chosen. Some problems are solved through projects developed in prototype plants and others are solved by using plant models. When the problems are solved by using plant models, students use emulation as an experimentation resource; they connect hardware in loop with the plant model by using PERI. Students who use prototypes to solve the problem can also use emulation to observe the controller performance before implementation. The PBL approach proposes a carefully selected rotation of student teams so that each stage of the project is developed by a different team, see figure 1. This rotation allows students to use

different experimentation resources, participate in the development of diverse projects, and, hence, learn of several industrial variables and contexts. The rotation also allows defining peer-assessment activities among teams.

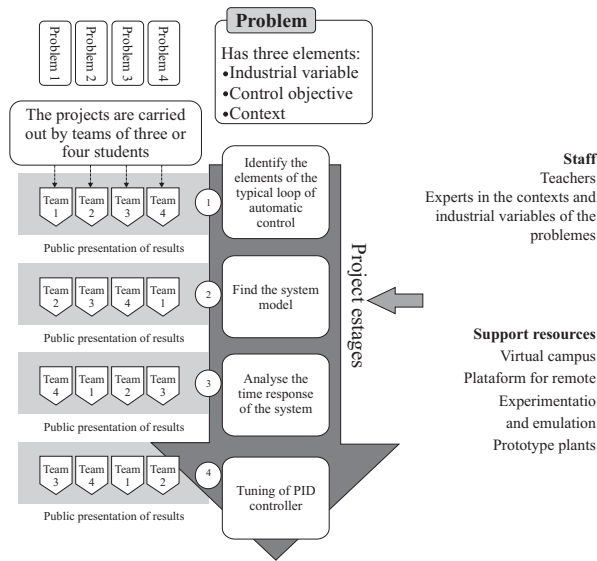

Figure 1 PBL approach applied to Fundamentals of Linear-Control Systems

Remote -Experimentation and emulation platform

The platform structure is made up a distributed computing system interconnected via Ethernet TCP/IP through two switches, one for external interconnection and another for the computer cluster that has four computer servers with Linux Knopix 5.0 operating system with RTAI 3.4, Real Time Application Interface. See figure 2 (taken of [18]). The servers also have DAQs (NI PCI-6229 National Instruments) to connect hardware; this connection is performed by Comedi software that provides open-source drivers, tools and libraries for data acquisition [19]. The analysis and simulation tools can be accessed via Internet by using a low bandwidth connection and a web browser. The user interfaces were developed using HTML and Java languages. The data processing (e.g. mathematical calculations) is performed using MATLAB® via TCP/IP connection. The

user access to the mathematical analysis and simulation tools through a PHP interface; there, this interface codifies the information that is sent to the process engine via a TCP/IP connection to the MATLAB® engine. The MATLAB® engine is used to calculate the desired operations and to store results in multi-dimensional variables, which are sent to the Workspace user for local manipulation and further analysis. In short, the interface server runs from MATLAB®, but the client interface is implemented via an applet in Java that does not require a prior installation of MATLAB®. The user interfaces for the simulation and analysis were developed by using Easy Java [11]. A detailed description of the platform is found in [16].

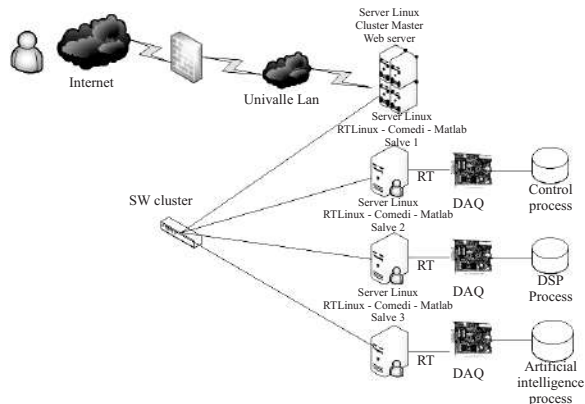

Figure 2 Remote-Experimentation and emulation Platform

On the PERI platform, users can carry out four types of emulation: Simple Software, Simple Physical, Distributed Software, and Distributed Physical. Simple Software emulation is executed by using only one server without hardware connected in loop. Simple Physical emulation allows connecting hardware in loop with the model constrained to use only one server. In the Distributed Software emulation, the model can be distributed in several servers without hardware connected in loop. Finally, the Distributed Physical Emulation permits to distribute the model into several servers and connect the hardware in loop. The web site of the emulation application contains graphical options to execute

the emulation types previously discussed. The platform has a management system that controls the access, availability of equipments, and user time.

Emulation

In the PERI platform, emulation is based on a Simulink model using RTAI-Lab blocks. As defined in [20], the RTAI project provides a tool set to develop block diagrams that can be compiled and executed on the RTAI real-time Linux operating system. To execute the emulation, the user must compile the model by means of the real-time toolbox. As a result of compilation, a folder is generated; this is compressed as a zip file and uploaded onto the platform. There, a target file is generated. Finally, the target file is run in one or several servers according to the type of emulation chosen.

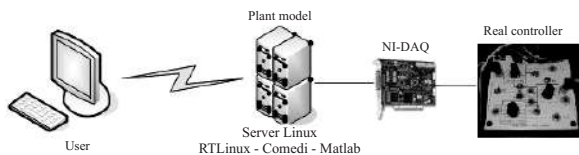

Figure 3 Emulation

When a Simple or Distributed Physical emulation is carried out to represent the dynamics of a plant, DAQ can be used to connect the real controller in loop, see figure 3. This connection must be defined from a model in Simulink by using Comedi blocks. In the distributed emulation case, the user defines how to distribute the model (*e.g.* a plant model) and creates a subsystem in Simulink for each part of the model. The subsystems are connected by using special blocks (sender and receiver). Subsystems are compiled by the real-time toolbox, separately. A folder is generated for each subsystem. Folders are compressed and uploaded onto the platform to generate target files. Each target file is executed in a different server. The emulation is a local resource in real time; however, the behavior of variables can be seen via internet by using JRTAILab [21] that also allows saving experimental data.

Remote experimentation

For remote experimentation, the user must choose a Simple Physical emulation or Distributed Physical emulation since these options allow connecting hardware in loop. In remote experimentation, students follow the same process used for emulation. There are three different operation conditions in remote experimentation that can be executed on the platform. In the first condition, the user operates a real plant that is controlled via emulated controller. In this instance, the controller model is executed in the servers and the plant is real. The DAQ is used to read and write signals of sensors and actuators, respectively. The Simulink model must include the control algorithms, Comedi blocks, and visualization blocks. In the designed PBL approach, this operation condition is used in the project stages devoted to testing and comparing controllers before implementation on the real system.

In the second condition, both a real plant and a real controller are operated in remote mode. The Simulink model only includes Comedi blocks and RTAI scopes for visualization. In this case, the platform is used to communicate the user (client) with the system and observe the performance of the controller and plant. This condition is used in the last stage of the project, after students have designed the control strategy; it is very useful to monitor and record the performance of system variables. In the third condition, the plant is operated in open loop and the Simulink model only has the Comedi and visualization blocks. This condition is helpful in the second and third stage of the project to obtain models of prototype plants via experimental tests, and analyze the system in the time and frequency domain. In each condition, source signals (*e.g.* Set points) can be generated from the Simulink model by source blocks. The user executes remote experimentation through the web page of the platform by means of JRTAILab. This Java applet allows observing and registering the behavior of system variables and changing parameters of controller and excitation sources.

Twelve problems were solved during the development of the first control course with PBL. Every project used emulation to evaluate the controller performance and six projects used the emulation tool as experimentation resource to represent the plant model and connect a real controller in loop. Models of plants like synchronic generator, dryer in sugar factory, DC motor with oscillating mode, boiler, magnetic levitator and antenna were analyzed by using the PERI tools.

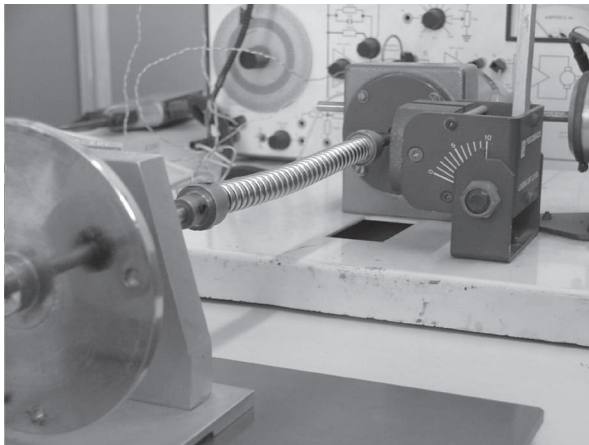

Figure 4 DC motor with oscillating mode

Case study: DC motor with oscillating mode

An example developed on a DC motor with oscillating mode (see figure 4) is used to show how to use emulation and remote experimentation tools through. The target is to control the motor speed with a PID controller. For this case, the Simple Physical emulation is used. This example shows the different cases of emulation and operation conditions of remote experimentation. Furthermore, this example stresses on the comparison between the real models and emulated model to validate emulation as an experimentation resource.

The slow dynamics of a plant was modeled by a second-order system via step test and the oscillating mode was modeled by a sinusoidal signal. Tests were performed by using the third operation condition of remote experimentation

described in the last subsection. The total transfer function of the plant is in equation 1.

$$G(s) = \frac{9.107s^2 + 1.265s + 242.3}{s^4 + 9.011s^3 + 30.93s^2 + 242.9s + 106.9} \quad (1)$$

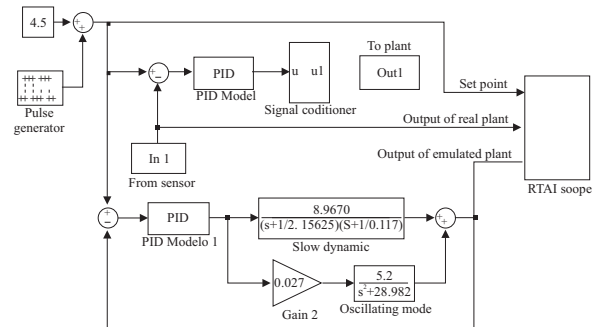

Figure 5 Block Diagrams to emulate a D.C. motor with oscillating mode. Block diagram to emulate a PID that controls a real and emulated motor

Figure 5 shows the block diagram in simulink used to compare the output of a real plant with the output of the emulated plant, when both plants are controlled with an emulated PID. The block diagram has two systems; the first one, on top of the figure, presents a real plant (DC motor with oscillating mode) controlled with an emulated PID by using the first operation condition of remote experimentation. The Comedi block labeled as *In1* reads the sensor signal and the Comedi block labeled as *Out1* writes the control signal in the DAQ. The second one corresponds to the emulated plant model when it is controlled with an emulated PID. The output of the real plant, output of the emulated plant, and set point are compared by means of a RTAI scope. These signals can be observed during the execution of emulation through JRTAILab. The DC motor model also was controlled with an external PID. In this case Comedi block *In1* reads the control signal and Comedi block *Out1* writes the error signal in the DAQ. In this case, a real PID controls a plant model. This experimentation is useful in tuning a real PID when the real plant is not available.

Data obtained was saved by means of JRTAILab and plotted by using Matlab® software. In figure 6, the response of the emulated plant (model) is

compared to the response of the real plant. The comparison between the output of a real plant and the output of an emulated plant, when both plants are controlled with a real PID controller connected to the platform through DAQ is shown in figure 7.

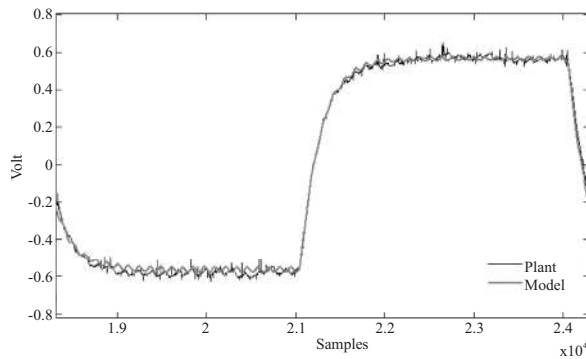

Figure 6 Model response vs. Plant response. The vertical axis corresponds to volts (V), the horizontal axis correspond to samples, $T_s=0.01s$

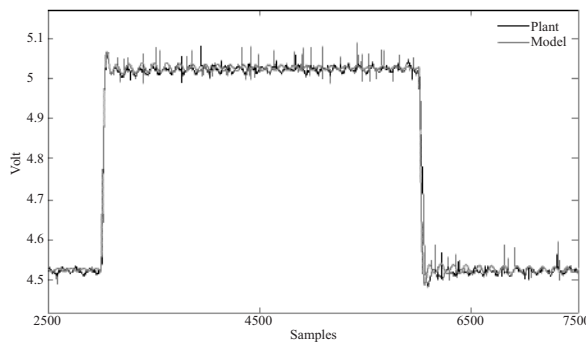

Figure 7 Comparison between the real plant and emulated plant with a real PID. The vertical axis corresponds to volts (V), the horizontal axis corresponds to samples, $T_s=0.01s$

When a real PID is used, the relative error between the output of the real plant and the emulated plant is lower than 5%. When an emulated PID is used, the relative error is lower than 2%. These error values demonstrate that experimentation with emulated models is a suitable resource for observing the dynamics of plant models, testing control algorithms, and tuning controllers when plants are not available. Note that the facilities of the PERI platform are suitable for the experimentation needs of each project stage.

Student Feedback

The platform developed was evaluated as a learning resource through three aspects: the contribution to learning, platform operation, and platform management. The students who used the emulation tool were consulted about these three aspects through a survey. The survey consisted of 12 queries presented as statements. Students evaluated the level of compliance of each statement. The scale ranged from 1 to 5; 1 no compliance and 5 excellent level of compliance. Table 1 presents survey statements. The survey evaluates the contribution to learning by queries Q4, Q8, and Q11; the platform operation by queries Q3, Q5, Q6, Q7, Q10, and Q12; and the platform management by queries Q1, Q2, and Q9.

The survey was applied twice; at the end of first control course (Survey 1) in the project stage concerning the design of controllers, and at beginning of the second control course (Survey 2) in the project stage about analysis of the plant in the frequency domain. Eight students filled out the survey the first time (Survey 1) and 16 students did so the second time (Survey 2). The reliability of the surveys was evaluated by means of the Alpha Cronbach coefficient [22]. The coefficient calculated from the data of Survey 1 was 0.931 and from the data of Survey 2 was 0.85. These coefficients show the good reliability of the survey.

The survey results are presented in figure 8. The queries about the contribution to learning emphasize on the relationship between the emulation tool and issues like: the control learning, problem context, and the PBL approach. Regarding the operation of the platform, the survey stresses on the guidelines for users, data formats, and visualization and operation capabilities. Some queries about platform management are focused on time management; this is an important characteristic for the PBL approach, because time management is a transversal skill encouraged by the approach and the platform must offer facilities so teams use platform tools according

to their needs of experimentation. The total score average of responses to queries for Survey 1 is 4.1 and 3.9 for Survey 2.

Table 1 Survey to Evaluate the Emulation Tool

Q1. The time defined to develop the emulation practices is enough to achieve the goal set.

Q2. The schedule to use platform is flexible.

Q3. The manuals and guidelines to use the platform are suitable and facilitate the understanding of the emulation tool.

Q4. Emulation is an appropriate tool for learning control systems.

Q5. The data are in appropriate formats for their analysis and for writing reports.

Q6. The platform has enough tools to develop the emulation practice completely.

Q7. The equipment is easily operated and the visualization of studied phenomena in the practice is suitable.

Q8. Emulation allows placing a real control problem in a laboratory environment

Q9. The resource management of the platform such as schedule, contents, data, etc. was appropriate.

Q10. The emulation tool worked correctly during the practices.

Q11. The platform resources are suitable for the teaching-learning methodology used in the course.

Q12. The platform equipment is technologically updated

In Survey 1, the score averages of responses to queries about contribution to learning and platform management are 4.5 and 3.5, respectively. For Survey 2, the averages are 4.3 and 3.3. The score average for the operation aspect is 3.8 in both surveys. Students satisfactorily evaluated the incorporation of the emulation tool in the learning process. Few students assessed statements of the learning aspect with compliance level less than 3; most responses to queries had compliance level 4 or 5.

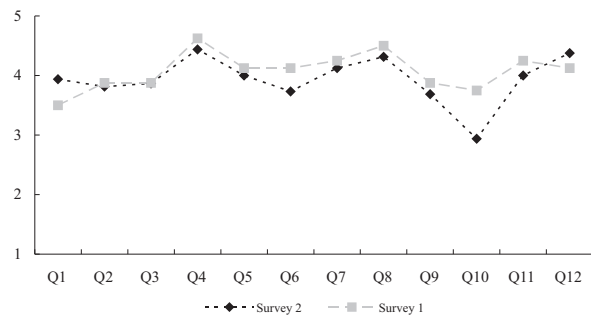

Figure 8 Survey results. The scale ranges from 1 to 5. 1 = no compliance and 5 = excellent level of compliance of the statement

The score averages of responses to queries Q4, Q8, and Q11 about the contribution to learning are 4.6; 4.5 and 4.3 for Survey 1 and for Survey 2 these are 4.4; 4.3 and 4.0, respectively. These results show that students have accepted emulation as an experimentation resource in the designed PBL approach for control systems. Students graded with high scores the statement referring to the capability of emulation to place a real control problem in a laboratory environment.

Conclusions

The learning of a control-linear system requires experimentation resources that bring students closer to real contexts. The emulation and remote experimentation tools are helpful resources to support the PBL approach, since these allow defining projects in diverse contexts, placing a real control problem in a laboratory environment, and experimenting with systems not available in the laboratory. Additionally, the use of the emulation facilitates the design of controllers before implementation on real contexts and allows extending the study examples of control courses to new fields by using a single technological resource.

The facility of the PERI platform for scheduling tasks is an interesting feature to be used in approaches like PBL that seeks to develop the autonomy to manage time and resources. With PERI, students choose their turn for experimentation according to their working hours and the development of the project.

The Remote Experimentation Platform for Engineering Education (PERI) has been accepted as an experimentation resource by students. This is observed in the high averages of responses to queries of the survey that inquires about the operation, management of the platform, and its contribution to learning. The incorporation of the platform in learning processes is increasing; currently, the teacher staff is designing new academic activities that involve resources of the platform.

References

1. A. Kolmos. "Estrategias para desarrollar curriculos basados a la formulación de problemas y organizados en base a proyectos". *Educator*. Vol. 33. 2004. pp. 77-96.
2. M. Frenay, B. Galand, E. Milgrom, B. Raucant. "Project- and Problem-based Learning in the Engineering Curriculum at the University of Louvain". *Management of Change: Implementation of Problem-Based and Project-Based Learning in Engineering*. E. De Graaff, A. Kolmos (editors). Ed. Sense Publishers. Rotterdam (Holanda). 2007. pp. 93 -108.
3. D. Bédard, R. Louis, M. Bélisle, R. Viau. "Project- and Problem-based Learning in Engineering Curriculum at the University of Sherbrooke: Impact on Students' and Teacher' Perceptions". *Management of Change: Implementation of Problem-Based and Project-Based Learning in Engineering*. E. De Graaff, A. Kolmos. (editors). Ed. Sense Publishers. Rotterdam (Holanda). 2007. pp. 109 -128.
4. L. R. J. Costa, M. Honkala, A. Lehtovuori. "Applying the Problem-Based Learning Approach to Teach Elementary Circuit Analysis". *IEEE Transactions on Education*. Vol. 50. 2007. pp. 41-48.
5. K. N. Jill. "Using Project-Based Assignments in a Graduate-Level Digital Signal Processing Course". *Digital Signal Processing Workshop, 12th - Signal Processing Education Workshop*, Wyoming (USA). 2006. pp. 135-140.
6. J. Northern. "Project-Based Learning for a Digital Circuits Design Sequence". *Region 5 Technical Conference*. Fayetteville (AR). 2007. pp. 358-362.
7. M. Duque, L. A. Osorio, A. Gauthier, F. Jimenez. "Active learning environments for automatic control courses." *International Conference on Engineering Education*. Valencia (Spain). 2003. pp. 1-8.
8. R. Morales-Menéndez, I. Y. S. Chavez, M. R. Cadena, L. E. A. G. L. E. Garza. "Control engineering education at Monterrey Tech". *American Control Conference*. Minneapolis (Minnesota). June 14-16. 2006. pp. 286-291.
9. S. Dormido, G. Farias, J. Sánchez, F. Esquembre. "Adding interactivity to existing Simulink models using Easy Java Simulations." *Decision and Control, 2005 and 2005 European Control Conference. CDC-ECC '05. 44th IEEE Conference*. Sevilla (España). 2005. pp. 4163-4168.
10. S. Dormido, C. Martin, R. Pastor, J. Sánchez, F. Esquembre. "Magnetic levitation system: a virtual lab in "easy Java simulation". *American Control Conference. 2004. Proceedings of the 2004*. Boston (MA). June 30-July 2. 2004. Vol.4. 2004. pp. 3215-3220.
11. F. Esquembre. *Easy Java Simulations Home Page*. <http://www.um.es/fem/Ejs/>. Consultada el 18 de Septiembre de 2008.
12. S. Dormido. "Control learning: present and future". *Annual Reviews in Control*. Vol. 28. 2004. pp. 115-136.
13. C. Lazar, S. Carari. "A Remote-Control Engineering Laboratory". *IEEE Transactions on Industrial Electronics*. Vol. 55. 2008. pp. 2368-2375.
14. W. Min, S. Jin-Hua, Z. Gui-Xiu, Y. Ohyama. "Internet-Based Teaching and Experiment System for Control Engineering Course". *IEEE Transactions on Industrial Electronics*. Vol. 55. 2008. pp. 2386-2396.
15. R. Dormido, H. Vargas, N. Duro, J. Sanchez, S. Dormido-Canto, G. Farias, F. Esquembre, S. Dormido. "Development of a Web-Based Control Laboratory for Automation Technicians: The Three-Tank System," *IEEE Transactions on Education*. Vol. 51. 2008. pp. 35-44.
16. J. Ramírez, E. L. Caicedo, C. Pinedo, E. Bacca, C. Ramos. "A platform for signals and systems internet-based education". *Inted conference*. Valencia (España). 2008. pp. 1-8.
17. L. Fernández-Samacá, M. Orozco-Gutiérrez, E. Núñez, J. M. Ramírez. "Linear Control System Course with a Project-Based Learning". *8th Active Learning in Engineering Education Workshop*. Bogotá. 2008. pp. 325-336.
18. A. Escobar. *Implementación de una Plataforma de Procesamiento Distribuido para Emulación de Procesos en Ingeniería*. Maestría en Ingeniería. Escuela de Ingeniería Eléctrica y Electrónica. Universidad del Valle. Cali. Colombia. 2007. pp. 21.
19. *COMEDI Linux control and measurement device interface*. www.comedi.org. Consultada el 15 de octubre de 2008.
20. *The RealTime Application Interface for Linux from DIAPM, RTAI*. <https://www.rtai.org/>. Consultada el 6 de octubre de 2008.
21. *RTAI-XML project team, JRTAILab*. http://artist.dsi.unifi.it/rtaixml/index.php?&MMN_position=5:5. Consultada el 21 de octubre de 2008.
22. R. Ledesma. "AlphaCI: un programa de cálculo de intervalos de confianza para el coeficiente alfa de Cronbach". *Psico-USF*. Vol. 9. 2004. pp. 31-37.